

Detail 1:1 Schienenhöhe

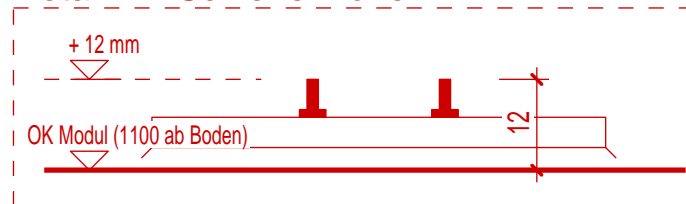

Modul Bogen

Mst. 1:10 30.10.2009/sa



Seitenteil D (Stärke 15 mm) 1 Stk.

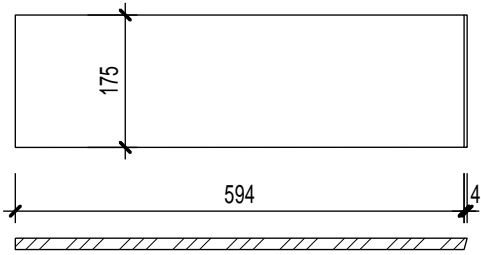

Seitenteil C (Stärke 15 mm) 1 Stk.

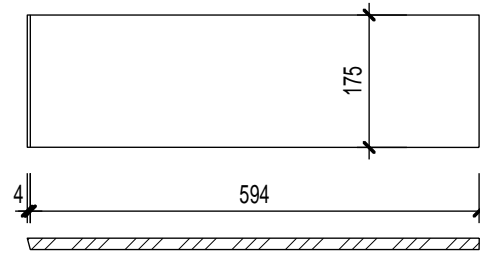

Beine 4 Stk.

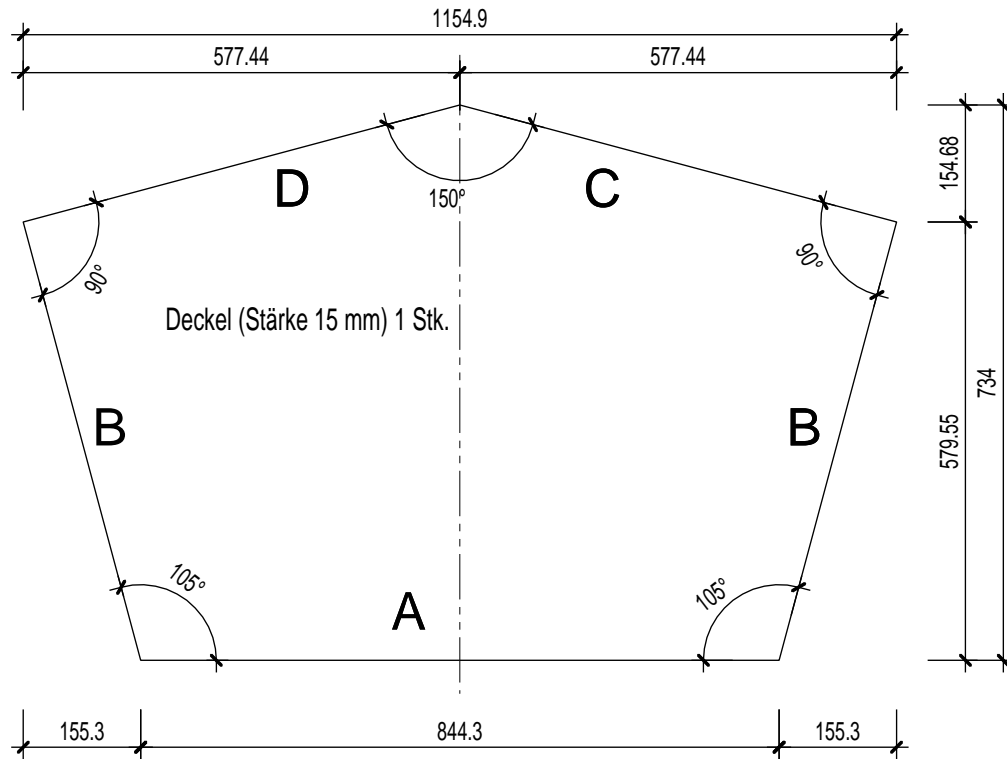
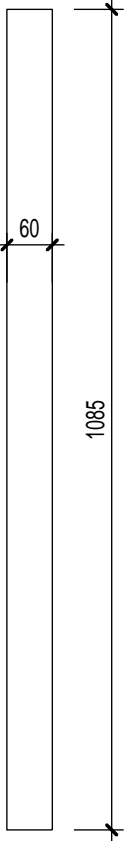
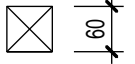

Seitenseite B (Stärke 15 mm) 2 Stk.

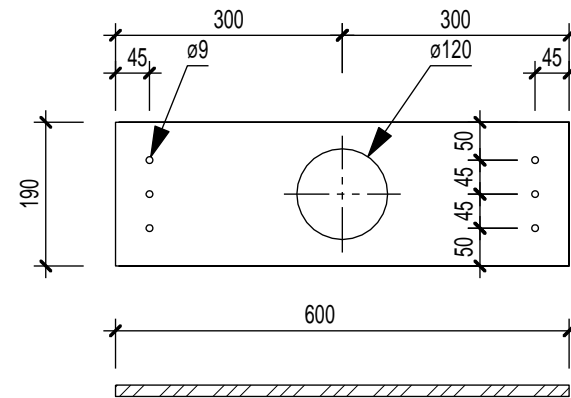

Seitenteil A (Stärke 15 mm) 1 Stk.

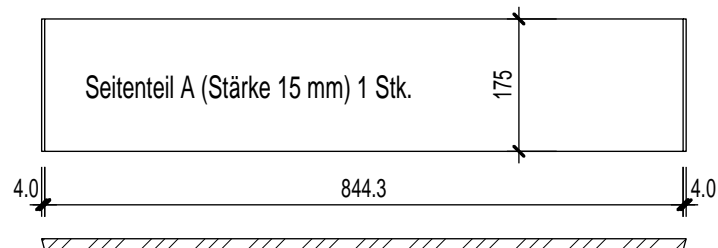

Teile für Modul Boden
Mst. 1:10 30.10.2009/sa

